

Assembly Instructions

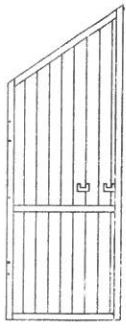

1PC

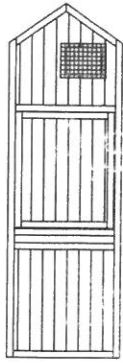

1PC

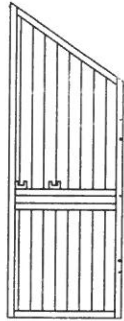

1PC

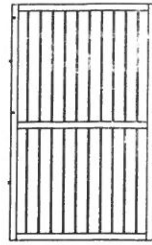

1PC

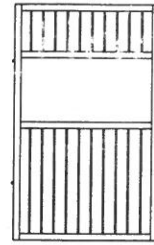

1PC



1PC



1PC



1PC

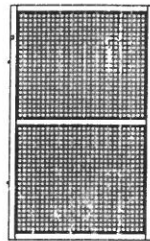

1PC

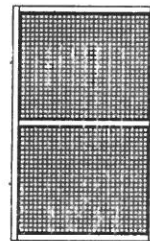

1PC

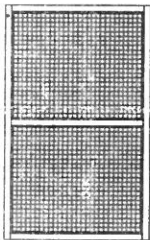

1PC

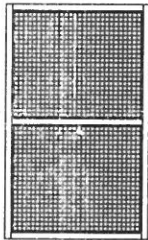

1PC

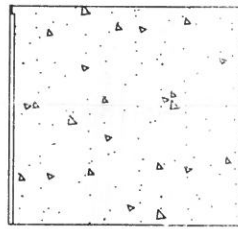

2PCS

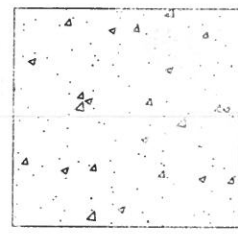

2PCS



1PC



1PC



1PC



2PCS

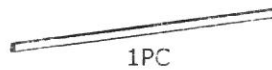

1PC



2PCS

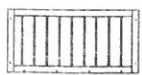

1PC



1PC



1PC



1PC



1PC



1PC



2PCS



2PCS

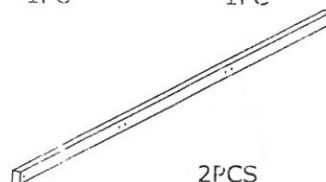

2PCS

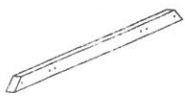

2PC



4PCS

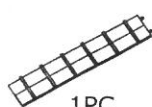

1PC



2PCS



2PCS

(A)  M3.5X60
26+1

(B)  M3.5X50
33+2

(C)  M3.5X40
40+2

(D)  M3.5X35
16+1

(E)  M3.5X25
20+1

(F)  M3.0X16
44+4



x6



x2



x2



x2



x1



x2

STEP-01

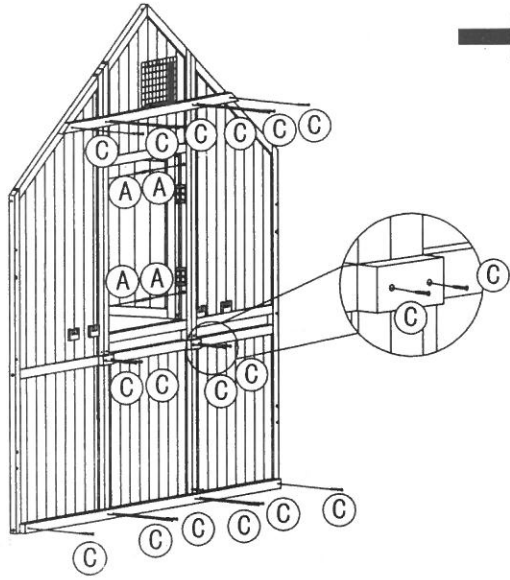

STEP-02

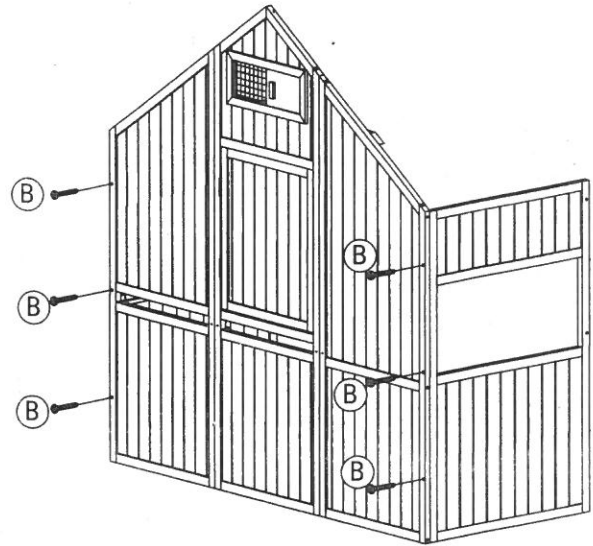

STEP-03

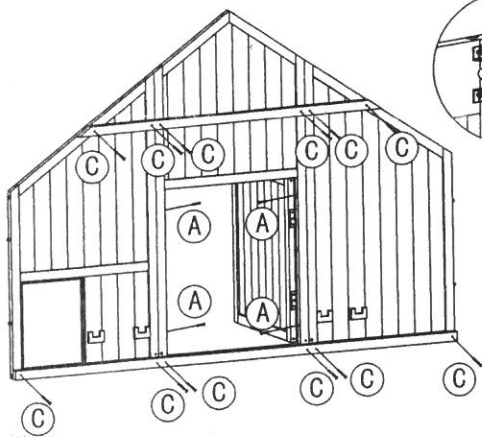

STEP-04

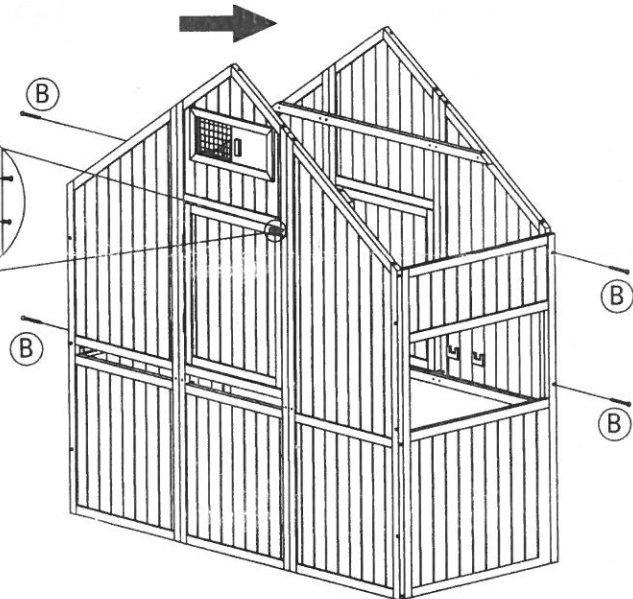

STEP-05

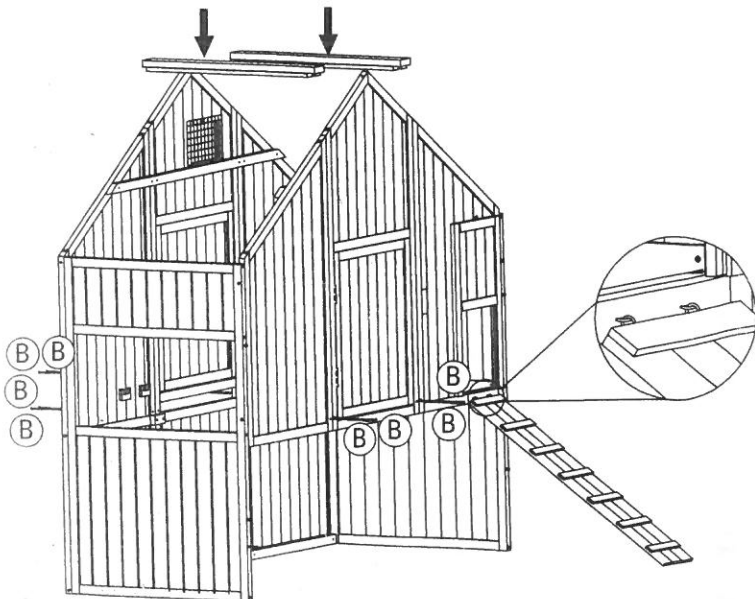

STEP-06

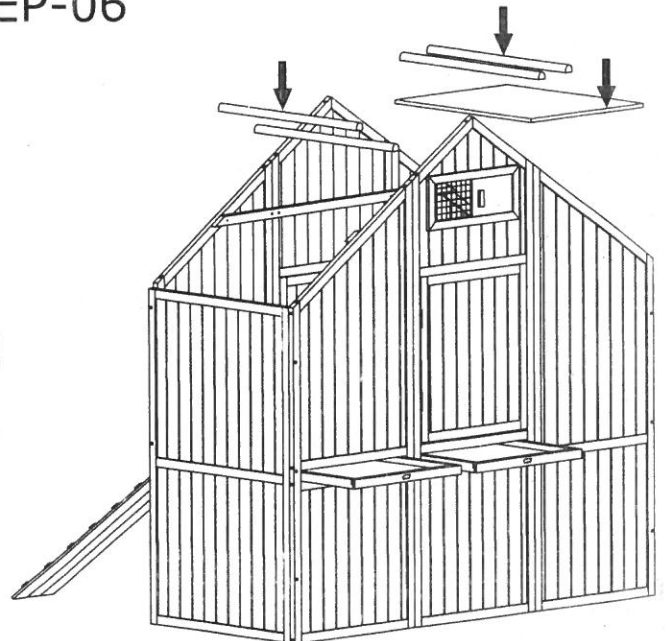

STEP-07

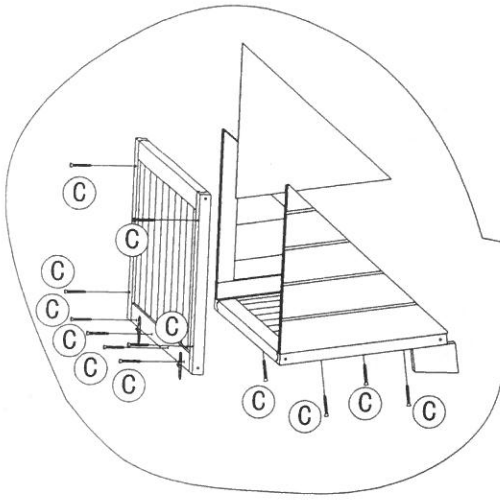

STEP-08



STEP-09

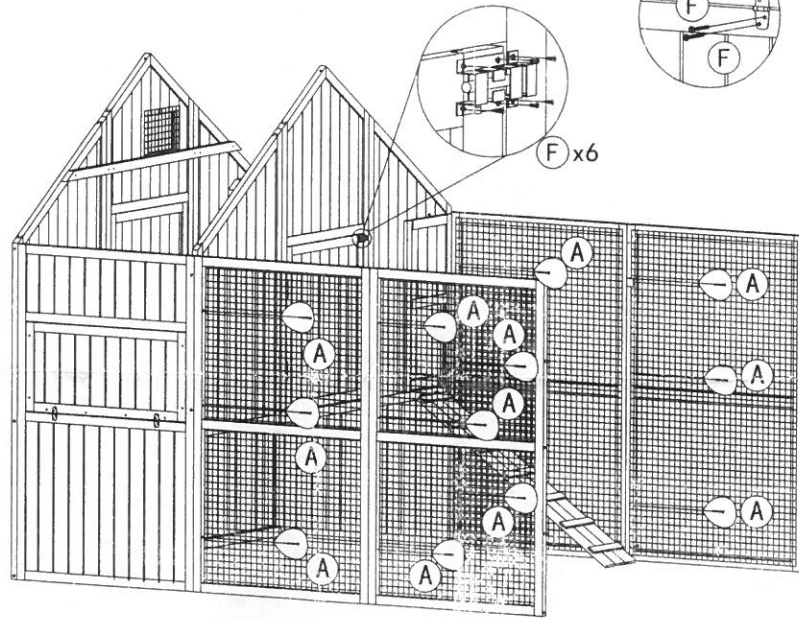

STEP-10

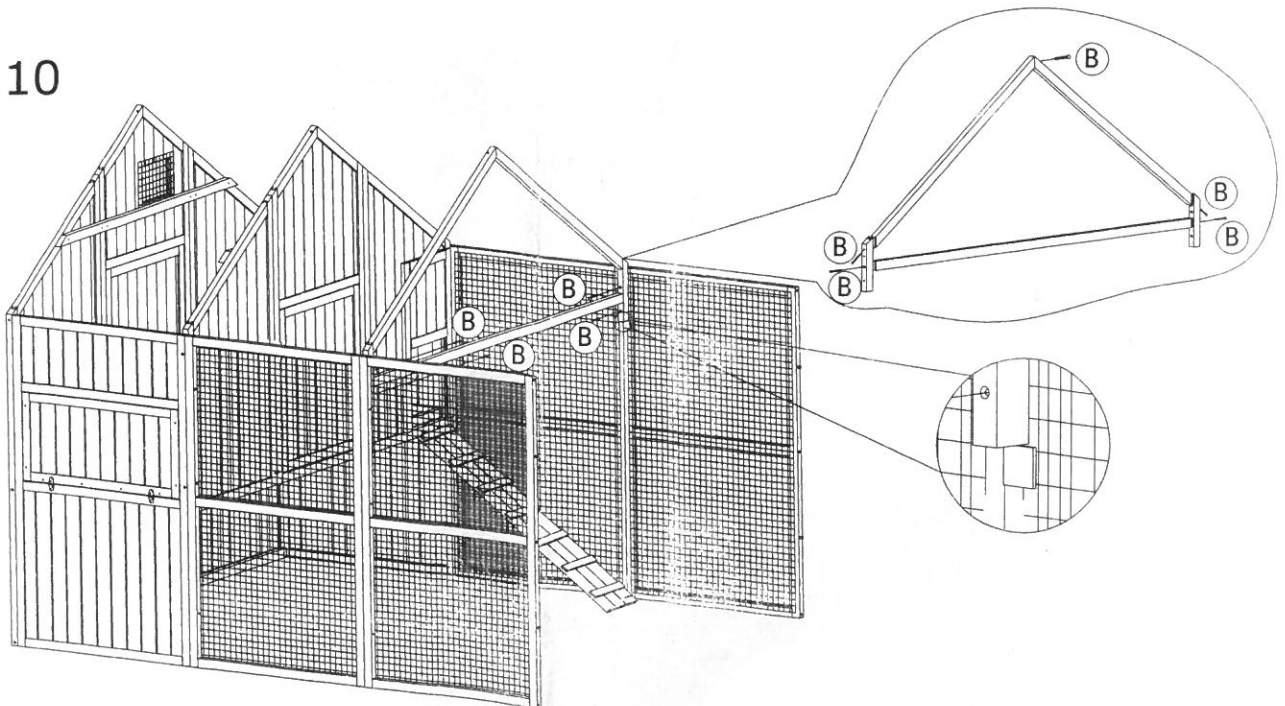

STEP-11

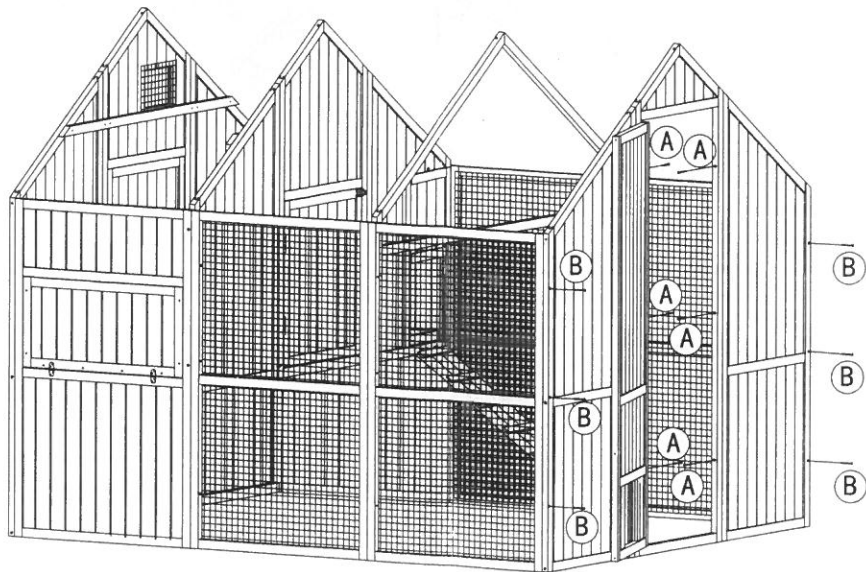

STEP-12

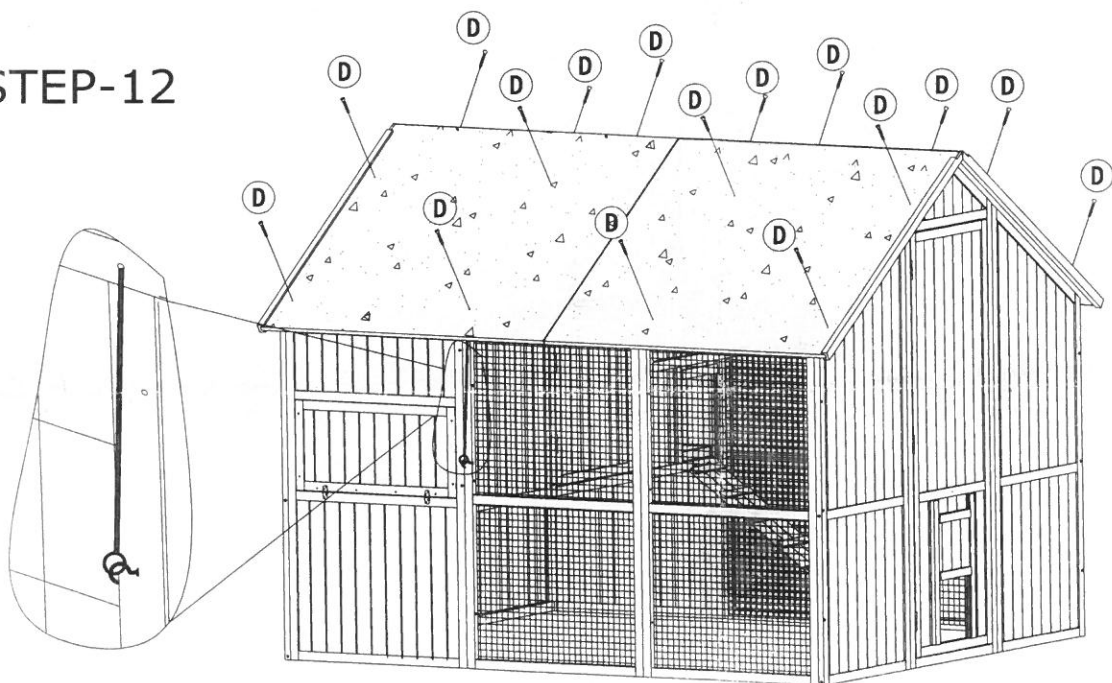

STEP-13

